

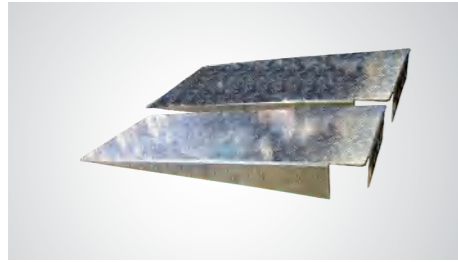

▲ Patented concealed safety lock control device with single-point manual lock release.



▲ Optional caster kits. Kits No. 40801.



▲ Optional extended aluminum drive-in ramp. (each lift needs 2 units.)
Kits No.: 40814 For 407-P, 407-HP
Kits No.: 40815 For 408-P, 408-HP, 409-HP



▲ Optional plastic oil tray (1 set, 4pcs)
Kits No. 40806 for 407-P, 407-HP, 408-P, 408-HP;
Kits No. 40807 for 409-HP.



▲ Optional Jack Tray. Kit No.: 40816



▲ Optional motor protective cover (with emergency stop switch),
Kits No.: 40810

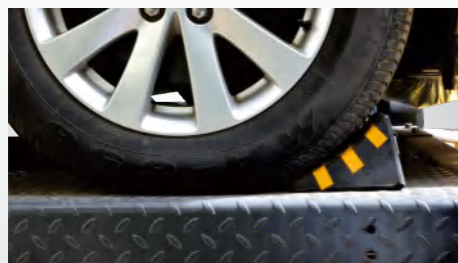

▲ Optional rubber wheel chock
P/N: 40811.



▲ Optional storage wave panels.
Kits No. 40812 for 407-P, 407-HP, 408-P, 408-HP;
Part No. 1004244001 for 409-HP
(each lift need 21 pcs).

COMMERCIAL GRADE 4-POST PARKING LIFT

PEAK[®]
World-class lifts

As a leader in the commercial-grade parking lift solutions industry, PEAK offers a blend of engineering and performance that is unmatched. These durable lifts are equipped with advanced, proprietary technologies, including a patented concealed lock control system, to maximize space efficiency and provide unparalleled parking convenience.

 Patent No.:
2023232158140



PEAK CORPORATION
<http://www.peaklift.cn>



No.3 Luomu Road, Muyuan, Shishan Town, Nanhai District, Foshan (528225), China
Tel:86-757-81102815 Fax:86-757-81102809

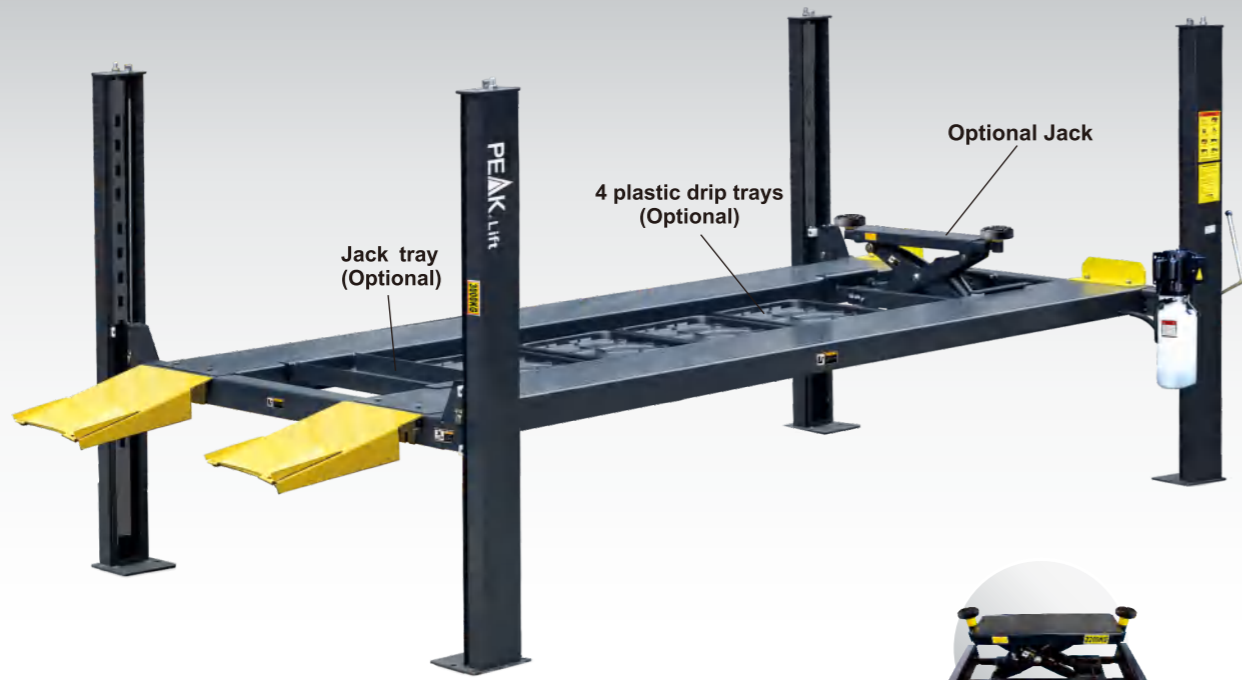

Optional J5H sliding jack with hand pump, 2.5" extension adapters included.



Optional J5H sliding jack with hand pump, 2.5" extension adapters included.

MODEL 407-P

The commercial-grade 407-P features a compact, low-clearance design, making it the perfect solution for maximizing space. With a 3000KG capacity, it fits a wide range of vehicles and supports back-to-back installation, ideal for massive deployments.

MODEL 407-HP

As an advanced version of 407-P, 407-HP enhances parking comfort with an extra high-lifting feature, allowing taller vehicles over 2 meters to be comfortably accommodated.

FEATURES

- Lifting capacity: 3000KG;
- Commercial grade, compact design;
- Support back-to-back installation;
- **PEAK** patented concealed safety lock control with single-point manual release;
- Dual safety devices mechanisms: both primary safety locks and cable-slack protection;
- Integrated non-skid diamond platforms;
- Double- shaped columns for enhanced strength;
- Foldable drive-on ramps;
- Power side column can be installed at any corner;
- Max lifting height over 2200mm to accommodate more taller vehicles (only 407-HP);
- Designed with pull rope (only 407-HP)
- High quality hydraulic cylinder design and manufactured at high standard.

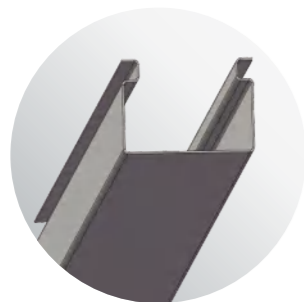

EXCLUSIVE FEATURE

Double- shape column

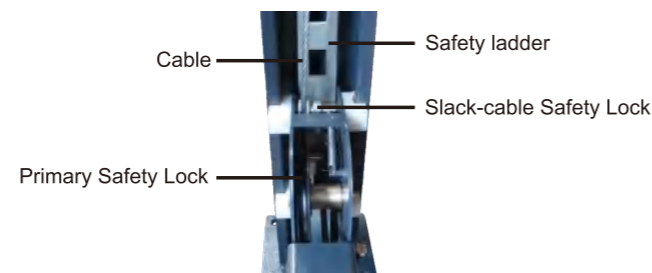

EXCLUSIVE FEATURE

Commercial double safety locks

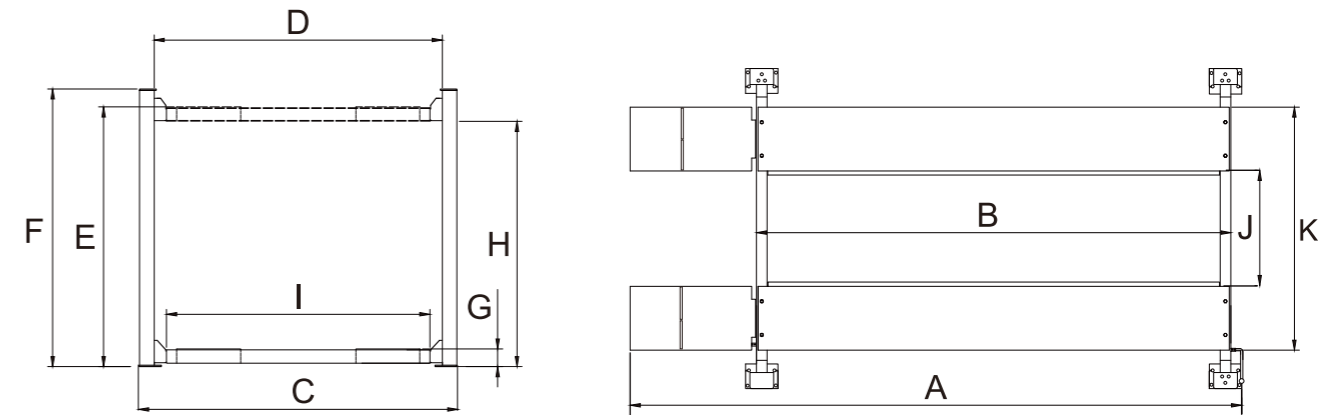

SPECIFICATIONS

Model	Lifting Capacity	Lifting Time	A	B	C	D	E	F	G	H	I	J	K	Gross Weight	Motor Power		
			Overall Length (Inc.Ramps)	Outside edge of crossbeams	Overall Width	Width Between Posts	Max. lifting height	Max. locking height	Overall Height	Minum Height	Max. Underneath Height	Max. Lock Underneath runway	Drive-Thru Clearance	Width Between Runways	Outside Edge of Runways		
407-P	3000kg	31S	4720mm (185 13/16")	3700mm (145 11/16")	2409mm (94 13/16")	2167mm (85 5/16")	1865mm (73 7/16")	1795mm (70 11/16")	2105mm (82 7/8")	125mm (4 15/16")	1765mm (69 1/2")	1695mm (66 3/4")	1956mm (77")	940mm (37")	1890mm (74 7/16")	651kg (1,435lbs)	3.0HP,220V
407-HP	3000kg	35S	5008mm (197 3/16")	3987mm (157")	2409mm (94 13/16")	2167mm (85 5/16")	2207mm (86 7/8")	2137mm (83 1/8")	2455mm (96 5/8")	125mm (4 15/16")	2107mm (82 15/16")	2037mm (80 3/16")	1956mm (77")	940mm (37")	1890mm (74 7/16")	687kg (1,515lbs)	3.0HP,220V

The images, technical specifications, and descriptions shown here are subject to change without prior notice. Please contact us for the latest information if necessary.



Optional J5H sliding jack with hand pump, 2.5" extension adapters included.



Optional J6H sliding jack with hand pump, 2.5" extension adapters included.

MODEL 408-P 408-HP

This premium series 408-P is another top-tier in our range of commercial parking lifts. Built for heavy-duty performance, it can lift up to 3,500KG and features a wider design for greater versatility with different vehicle types

FEATURES

- Lifting capacity: 3500KG;
- Premium comfortable design;
- Support back-to-back installation;
- PEAK patented concealed safety lock control with single-point manual release;
- Dual safety devices mechanisms: both primary safety locks and cable-slack protection;
- Integrated non-skid diamond platforms;
- Double- shaped columns for enhanced strength;
- Foldable drive-on ramps;
- Power side column can be installed at any corner;
- Max lifting height over 2200mm to accommodate more taller vehicles (only 408-HP);
- Designed with pull rope (only 408-HP);
- High quality hydraulic cylinder design and manufactured at high standard.

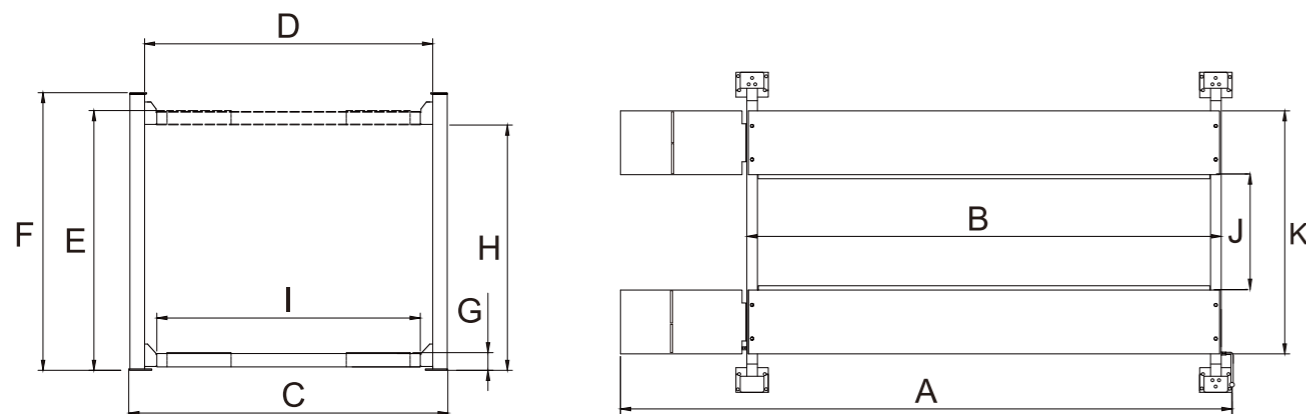

MODEL 409-HP

As the deluxe model in PEAK's line of commercial parking lifts, 409-HP is engineered to meet the most demanding requirements. Featuring extremely high-lifting and impressive 4000KG load capacity, 409-HP can accommodate a wide range of vehicles, including cars, SUVs, pickups, and light trucks.

FEATURES

- Lifting capacity: 4000KG;
- Deluxe design, provides unmatched parking experience;
- Support back-to-back installation;
- High lifting capability over 2200mm, perfect for large vans and light trucks;
- Designed with pull rope;
- PEAK patented concealed safety lock control with single-point manual release;
- Dual safety devices mechanisms: both primary safety locks and cable-slack protection;
- Integrated non-skid diamond platforms;
- Double- shaped columns for enhanced strength;
- Foldable drive-on ramps;
- Power side column can be installed at any corner;
- High quality hydraulic cylinder design and manufactured at high standard.

SPECIFICATIONS

Model	Lifting Capacity	Lifting Time	A Overall Length (Inc.Ramps)	B Outside edge of crossbeams	C Overall Width	D Width Between Posts	E Max. lifting height	F Max. locking height	G Overall Height	H Minium Height	I Max. Underneath Height	J Max. Lock Underneath runway	K Drive-Thru Clearance	L Width Between Runways	M Outside Edge of Runways	N Gross Weight	O Motor Power
408-P	3500kg	40S	5285mm (208 1/16")	4258mm (167 5/8")	2604mm (102 1/2")	2358mm (92 13/16")	1872mm (73 11/16")	1802mm (70 15/16")	2105mm (82 7/8")	145mm (5 11/16")	1752mm (69")	1682mm (66 1/4")	2074mm (81 5/8")	940mm (37")	1890mm (74 7/16")	709kg (1,563lbs)	3.0HP,220V
408-HP	3500kg	46S	5285mm (208 1/16")	4258mm (167 5/8")	2604mm (102 1/2")	2358mm (92 13/16")	2227mm (87 11/16")	2157mm (84 15/16")	2455mm (96 5/8")	145mm (5 11/16")	2107mm (82 15/16")	2037mm (80 3/16")	2074mm (81 5/8")	940mm (37")	1890mm (74 7/16")	757kg (1,669lbs)	3.0HP,220V
409-HP	4000kg	67S	6049mm (238 1/8")	5022mm (197 3/4")	2777mm (109 5/16")	2531mm (99 5/8")	2237mm (88 1/16")	2167mm (85 5/16")	2455mm (96 5/8")	155mm (6 1/8")	2097mm (82 9/16")	2027mm (79 13/16")	2247mm (88 7/16")	1077mm (42 3/8")	2093mm (82 3/8")	887kg (1,956lbs)	3.0HP,220V

The images, technical specifications, and descriptions shown here are subject to change without prior notice. Please contact us for the latest information if necessary.